

BATHROOM ELEVATIONS

SCALE: 3/8"=1'-0"  
4

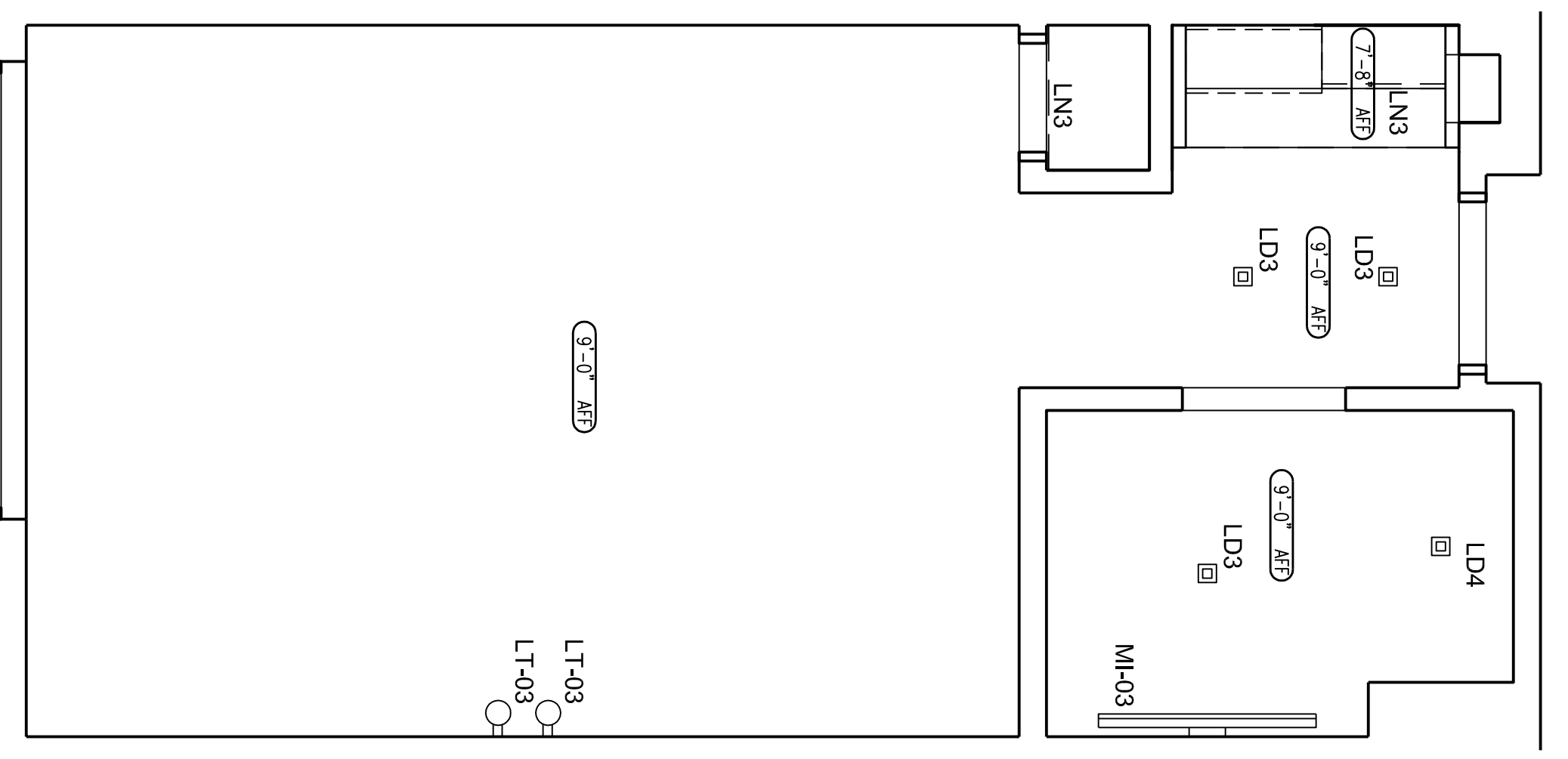
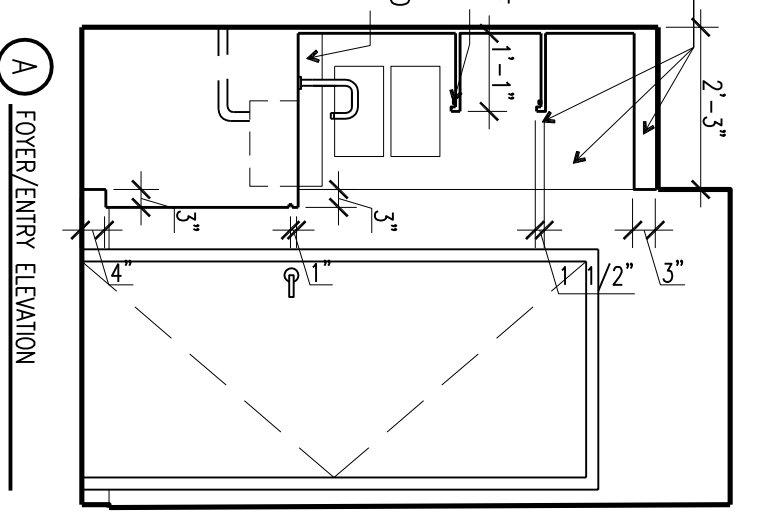
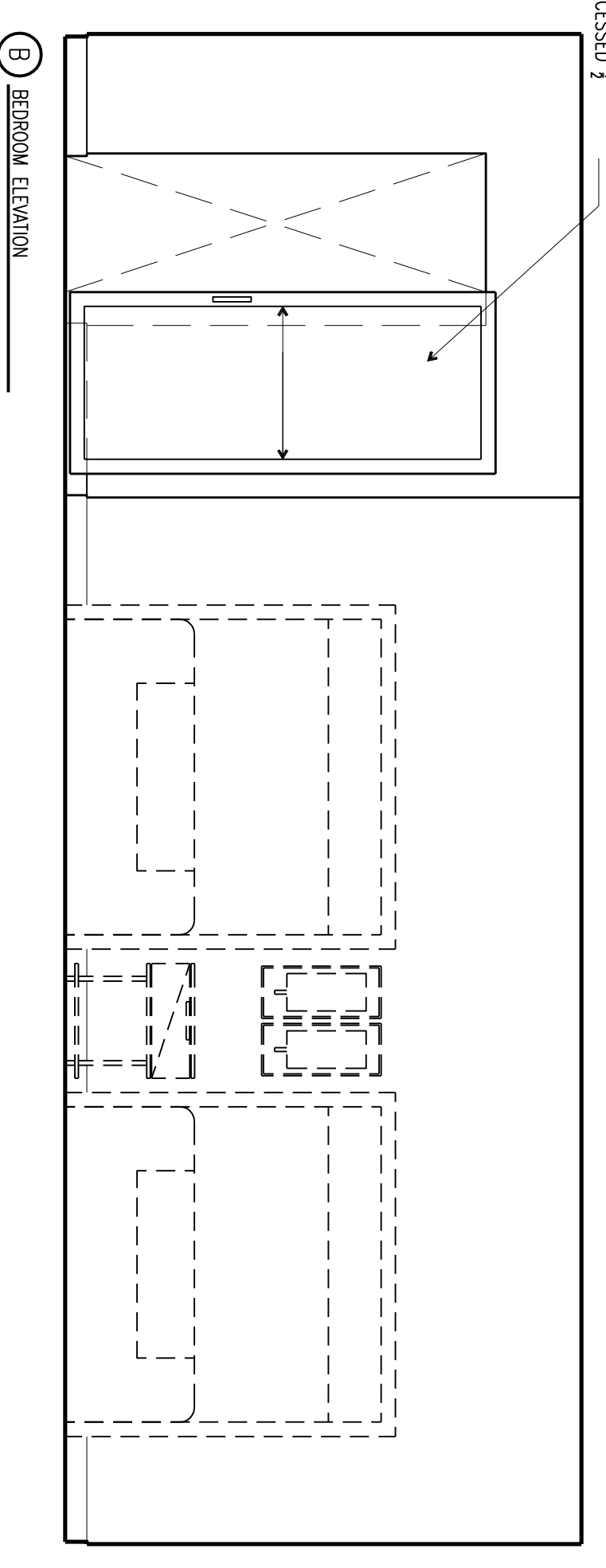
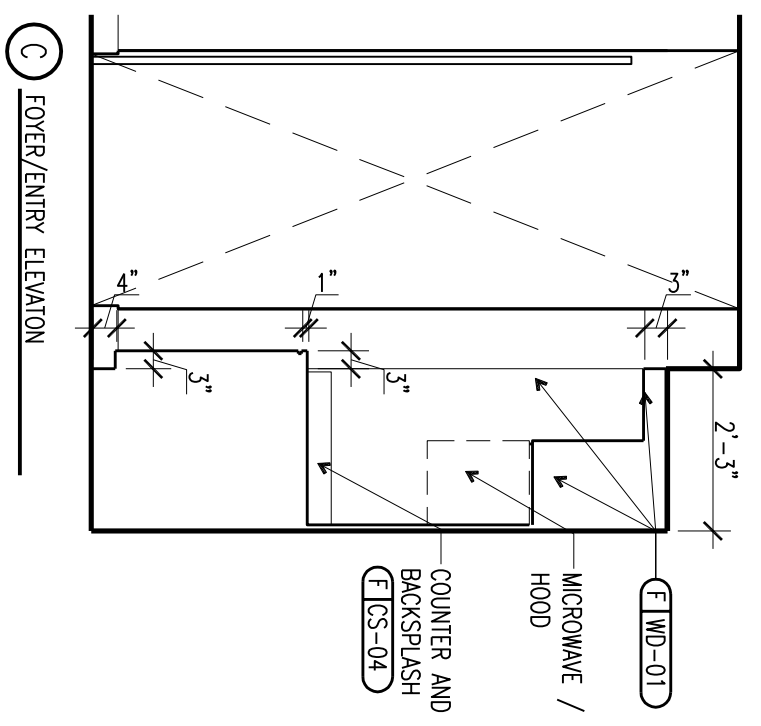
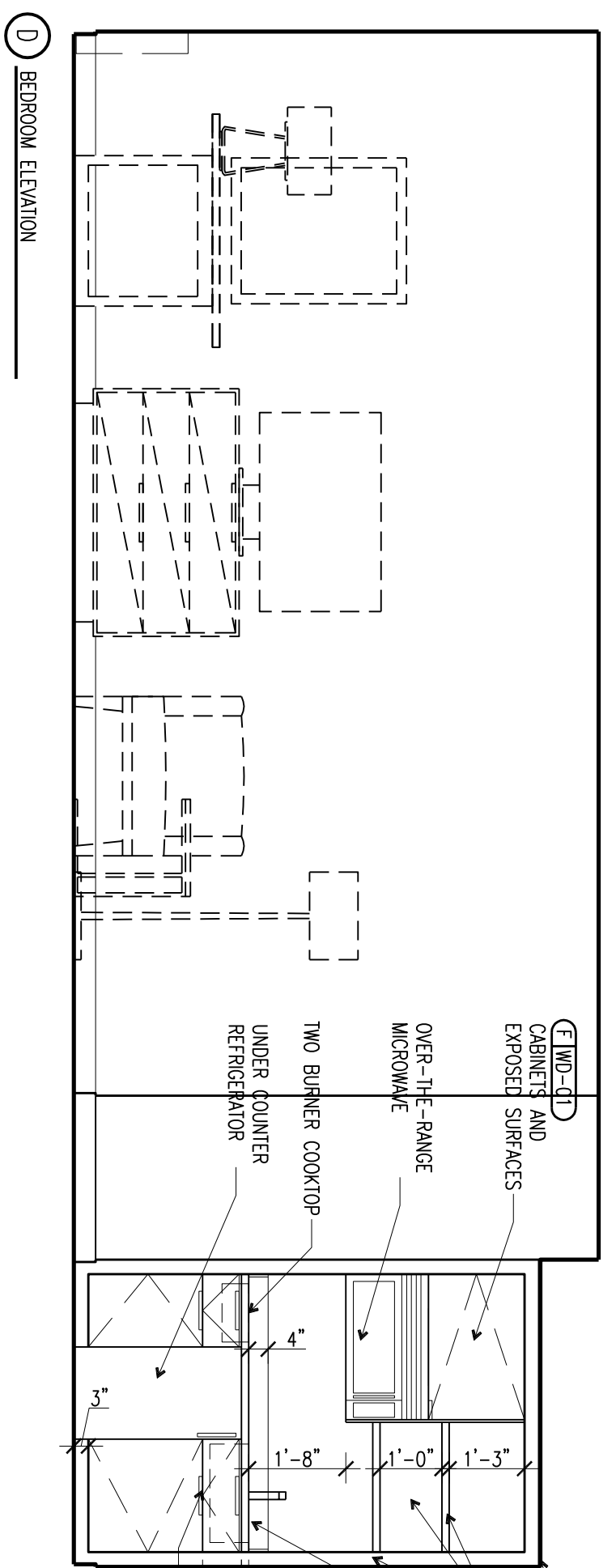
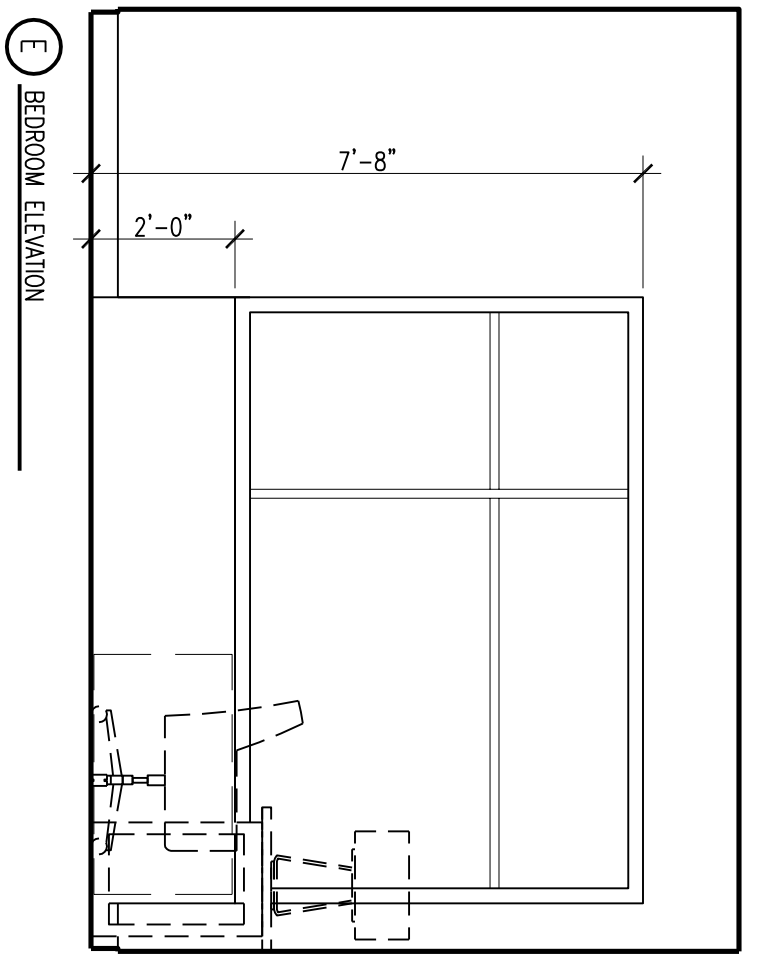
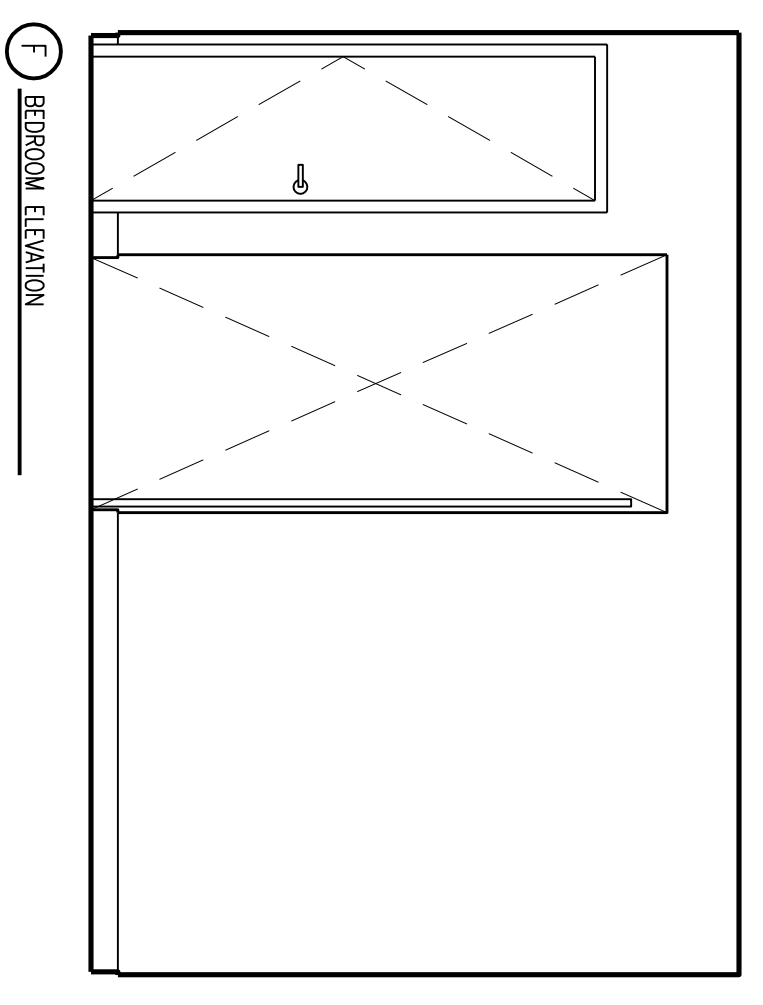

LEGEND:

- LD3 LED RECESSED DOWNLIGHT
- LD4 LED RECESSED DOWNLIGHT
- LNS LED LINEAR SURFACE MOUNTED SHELF LIGHT
- LT-03 DECORATIVE WALL SCOFFCE
- M-03 ILLUMINATED MIRROR

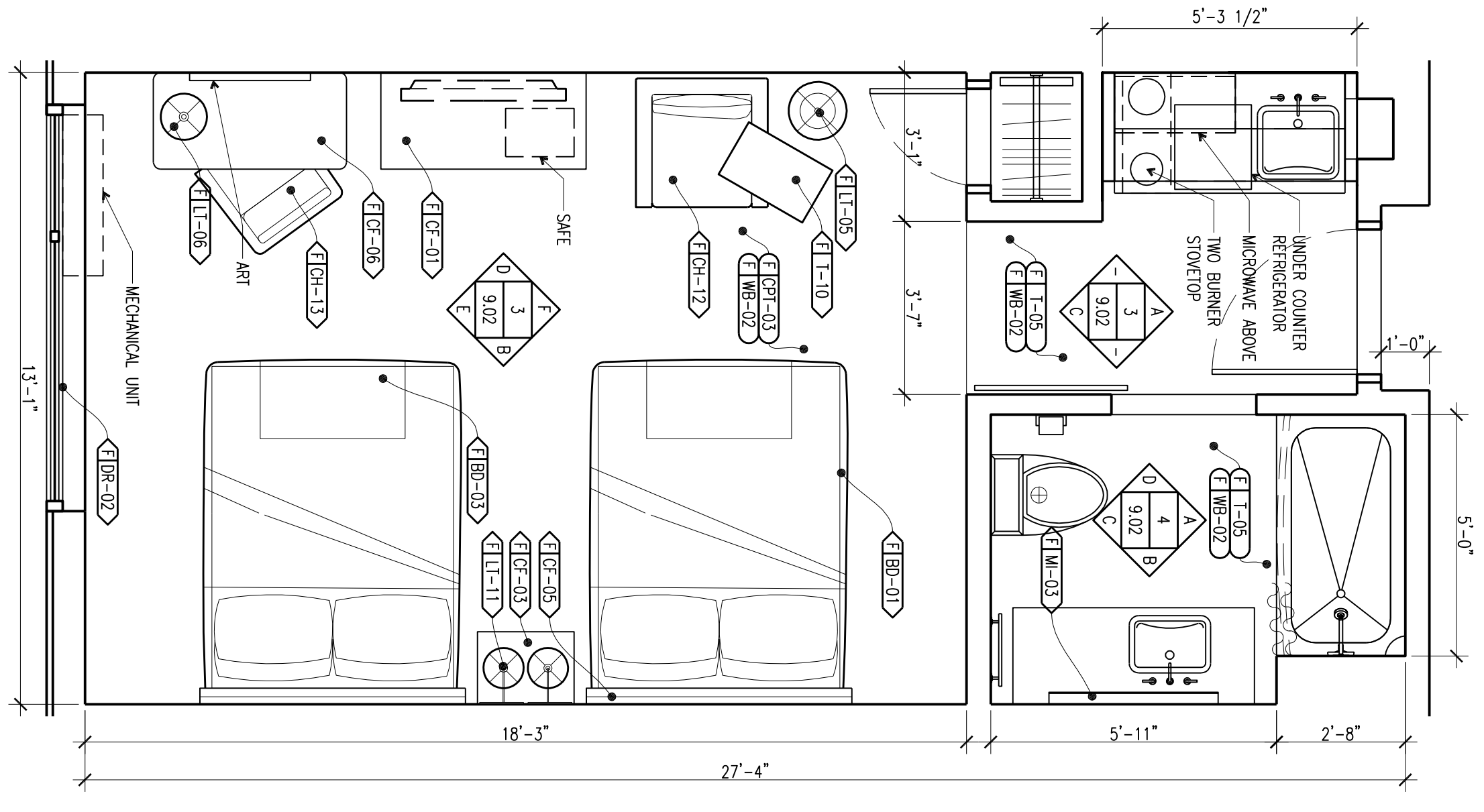

GUEST ROOM ELEVATIONS

SCALE: 3/8"=1'-0"  
3

GUEST ROOM RCP

SCALE: 3/8"=1'-0"  
2

GUEST ROOM PLAN

SCALE: 3/8"=1'-0"  
1

SHEET NUMBER: ID9.02  
PROJECT NAME: BEST WESTERN EXECUTIVE RESIDENCY PROTOTYPE  
DATE: JANUARY 2016  
SHEET DESCRIPTION: ES Q/Q GUEST ROOM STUDIO PLANS AND ELEVATIONS

RESPONSIBILITIES:  
YOU EXPRESS, UNDERSTAND AND AGREE THAT YOUR USE OF AND RELIANCE ON THESE ARCHITECTURAL SPECIFICATIONS PROVIDED BY BEST WESTERN INTERNATIONAL, INC. ("BWI") IS AT YOUR SOLE RISK AND IS MADE AVAILABLE ON AN "AS IS" AND "AS AVAILABLE" BASIS. YOU RELEASE, WARRANTIES, OR GUARANTEES WITH REGARD TO THE APPROPRIATENESS, ACCURACY, SUFFICIENCY, CORRECTNESS, TIMELINESS, AND/OR RELATED SPECIFICATIONS AND/OR RELATED CONTENT, INCLUDING WITHOUT LIMITATION COMPLIANCE WITH THE AMERICANS WITH DISABILITIES ACT (FEEDBACK, STATE OR FEDERAL), AND/OR ANY SPECIFIC CODE OR ASSOCIATION FOR ANY SPECIFIC OR INTENDED PURPOSE. BWI EXPRESSLY DISCLAIMS ALL WARRANTIES OF ANY KIND, WHETHER EXPRESS OR IMPLIED, INCLUDING WARRANTIES OF MERCHANTABILITY, FITNESS FOR A PARTICULAR PURPOSE AND NON-INFRINGEMENT.  
NO PART SHALL BE LIABLE FOR ANY DIRECT, INDIRECT, PUNITIVE, INCIDENTAL, SPECIAL, CONSEQUENTIAL DAMAGES OR ANY DAMAGES WHATSOEVER. LIMITATION DAMAGES FOR LOSS OF USE, DATA, OR PROFITS ARISING OUT OF OR IN ANYWAY CONNECTED WITH THE USE OR PERFORMANCE OF ANY BIM PROVIDED OR NOT PROVIDED OUT OF THE USE OF THE BIM PLANS OR SPECIFICATIONS, IN WHOLE OR IN PART, WHETHER BASED ON CONTRACT TORT NEGLIGENCE STRICT LIABILITY OR OTHERWISE. EVEN IF THIS AGREEMENT IS TO BE DISCONTINUED, THIS AGREEMENT SHALL SURVIVE AND BE APPLICABLE TO ANY AND ALL DAMAGES, ALL (USE OF THE PLANS) AND/OR SPECIFICATIONS IS DONE AT YOUR OWN DISCRETION AND RISK AND YOU WILL BE SOLELY RESPONSIBLE FOR ANY DAMAGES THAT RESULT THEREFROM. IF YOU ARE DISSATISFIED WITH ANY PORTION OF THE BIM PLANS AND/OR SPECIFICATIONS, OR WITH ANY OF THESE SPECIFICATIONS, YOU ARE HEREBY ENCOURAGED TO DISCONTINUE THE EXCLUSIVE RELIANCE TO DISCONTINUE USING SUCH PLANS AND SPECIFICATIONS. YOU ARE SOLELY RESPONSIBLE FOR DETERMINING THE AGENCY AND SPECIFICATION FOR YOUR PARTICULAR NEEDS. YOU ARE HEREBY ENCOURAGED BY BIM TO CONSULT WITH THE APPROPRIATE PROFESSIONAL ADVISORS TO DETERMINE THE AGENCY AND SPECIFICATION FOR YOUR PARTICULAR NEEDS AND/OR SPECIFICATIONS WITH APPLICABLE LAWS FOR ANY SUCH PLANS) AND/OR SPECIFICATIONS.

NOT FOR CONSTRUCTION